

Eppendorf SOP

Standardanweisung für Pipetten · Standard Operating Procedure for pipettes
Procédure standard pour pipettes · Procedura operativa standard per pipette
Instrucciones de trabajo estándar para pipetas

eppendorf

Inhalt / Contents / Sommaire / Índice / Índice

Standardanweisung für Pipetten	3
Standard Operating Procedure for pipettes	27
Procédure standard pour pipettes	51
Procedura operativa standard per pipette	75
Instrucciones de trabajo estándar para pipetas	99

Contents

1	Measuring station and accessories	28
2	Testing conditions and pipetting conditions	29
3	Calibration of pipettes, dispensers and burettes	30
4	Evaluation	31
5	Sterilizing and cleaning	32
6	Checking for leaks	33
7	Troubleshooting	34
8	Adjustment	35
8.1	Adjusting pipettes (adjustable-volume)	35
8.2	Adjusting pipettes (fixed-volume)	35
8.3	Adjusting for liquids with a density different to that of bidistilled, degassed water	40
9	Factor Z for distilled water	41
10	Technical specifications of Eppendorf pipettes	42
10.1	Fixed-volume pipettes	42
10.2	Adjustable pipettes	42
10.3	Multi-channel pipettes	44
10.4	Multipettes	45
10.5	Bottle-top dispensers / burettes	46
10.6	Error limits in accordance with EN ISO 8655	47
11	Index	50

1 Measuring station and accessories

Test conditions in accordance with EN ISO 8655

These test conditions are valid for all Eppendorf pipettes and dispensers in the appropriate form. No special reference is made to the different tip ejection mechanisms or the differences between manual and electronic pipettes.

The following components are required for a measuring station for calibrating / adjusting pipettes:

Fine balance tested by Board of Weights and Measures

(e.g. Sartorius, Mettler or others).

Resolution / accuracy:

The relationship between the error limits of the pipettes to be tested and the graduation scale of the balance ensures that scattering within a measurement series is recorded with sufficient accuracy to evaluate the systematic and random error in accordance with the EN ISO 8655 standard. Manufacturer specifications sometimes deviate from the ISO standard and demand a high degree of weighing accuracy (see "Technical specifications").

Minimum requirements for balances

Selected volume* of the pipette to be tested	Resolution (mg)
1 µl to 10 µl	0.001
> 10 µl to 100 µl	0.01
> 100 µl to 1,000 µl	0.1
> 1 ml to 10 ml	0.1
> 10 ml to 200 ml	1

* For practical purposes the nominal volume may be used to choose the balance. Appropriate, a photometric test could be used for volumes < 10 µl.

Evaporation

Especially for small volumes below 50 µl, errors due to evaporation of the test liquid during measurements should be taken into consideration.

This can be done by means of an evaporation trap or other equipment which prevents evaporation.

Electrostatic charge

For test volumes ≤ 50 µl, electrostatic discharge to all parts which come into direct or indirect contact with the pipettes must be prevented. The tubes provided by Eppendorf as well as the moisture trap with lid are made of glass, which minimizes electrostatic charge.

Measuring station

Calibration software and accessories for your balance (PICASO, order no. 3113 000.014) are recommended for electronic processing of measuring data.

Measuring station and accessories for test volumes	up to 50 µl	50 µl and more
Balance setting	int 1 (integration time) asd 2 (standstill time)	int 1 asd 2
Weighing vessel, vessel adapter	Vessel, ø 15 mm (order no. 3113 808.003, 3 pcs.) with vessel adapter ø 15 mm	Vessel ø 24 mm (order no. 3113 807.007, 3 pcs.) with vessel adapter ø 24 mm
Evaporation protection	Glass moisture trap	Approx. 10 ml distilled water in a dish inside the balance

For pipettes with a **maximum volume of 5,000 µl and above**, the weighing plate with a vessel of an appropriate size is used instead of the special Eppendorf balance adapter. The moisture trap is not used in these cases.

2 Testing conditions and pipetting conditions

(See EN ISO 8655, Part 6)

Test room

The tests should be carried out in a draught-free room with a stable environment.

The testing room should have a constant temperature between 15 °C and 30 °C ($\pm 0,5$ °C) and a relative humidity above 50 %.

Temperature differences

Prior to the test, the instruments to be tested and the test liquid should be left to stand for a sufficient length of time in the test room (at least 2 hours) to reach equilibrium with the room temperature.

Under no circumstances should the pipette or the measuring site be exposed to direct sunlight or other harmful conditions.

Test liquid

Distilled or deionized water, "grade 3" conforming to ISO 3696, degassed or air equilibrated. The water shall have room temperature.

Instruction manual

In view of the many different types of volume measuring devices, it is particularly important to refer to the instruction manual during testing. EN ISO 8655, Part 1 therefore states that the instruction manual forms part of the delivery package of the device and EN ISO 8665, Part 6 that the contents of the instruction manual must be observed.

3 Calibration of pipettes, dispensers and burettes

Adjustable pipettes: three different volumes are tested:

- the nominal volume (10 measured values)
- approximately 50 % of the nominal volume (10 measured values)
- the lower limit of the useful volume range or 10 % of the nominal volume (10 measured values).

Multi-channel pipettes: the following volumes are tested for each channel:

- the nominal volume (10 measured values)
- approximately 50 % of the nominal volume (10 measured values)
- the lower limit of the useful volume range or 10 % of the nominal volume (10 measured values).

Multipette® 4780, Multipette® plus, Multipette® pro, Multipette® stream and Multipette® Xstream: the nominal volume is tested (10 measured values) with the Eppendorf Combitip®.

Bottle-top dispensers and burettes: the nominal volume is tested (10 measured values).

Mode of operation

- Attach the selected tip onto the nose cone of the pipette or insert the appropriately-sized Combitip into the Multipette.
- Adjustable pipettes: set the smallest volume which is to be tested. Bottle-top and Top Buret: set the nominal volume. Multipettes: set the volume selection dial to Position 1.
- The first value of the Multipette 4780 is discarded (when the Combitip is fully pulled), in the case of the Multipette 4980, the empty stroke is executed (when the Combitip is fully pulled).
- Fill the weighing vessel with test liquid up to a height of at least 3 mm.
- Adjustable pipettes: aspirate and then dispense the set volume five times to reach a humidity equilibrium in the dead air volume.
- Replace the disposable tip and pre-wet the new tip one time.

Aspirate the volume which is to be tested from the liquid supply as follows:

- Hold the pipette vertically.
- Immerse the tip approximately 2 – 3 mm into the test liquid.
- Aspirate the test volume slowly and uniformly.
Observe the waiting period of 1 – 3 sec., for the Research 500 – 5,000 µl 5 sec.
(Take note: the waiting time depends on the size of the pipette tip; see instruction manual).
- Remove the pipette tip from the test liquid slowly and uniformly. Remove any remaining liquid by placing the pipette tip against the inside of the vessel.

Dispense the test volume into the weighing vessel as follows:

- Touch the filled tip against the inside of the weighing vessel at an angle of approx. 30° to 45°.
- Dispense the test volume slowly and uniformly up to the first stop (measuring stroke).
- Press the control button to the second stop (blow-out) and dispense any liquid remaining in the tip (not applicable to dispensers and burettes).
- Hold down the control button and pull the tip up along the inside of the weighing vessel.
- Let the control button slide up again.
- Determine weight.
- Document all measured values from a measurement series as described above. Evaluate the systematic and random errors.
- With adjustable pipettes, proceed in the same way, using 50 % of the nominal volume and the nominal volume.
- With multi-channel pipettes, the measured values of all channels per test volume are summarized for evaluation of the systematic and random errors.

4 Evaluation

Calculation of the systematic error

Mean value of the measured volumes:

$$\bar{x} = \frac{\sum \text{All measured values}}{n} \cdot z$$

n = number of measured values

For exact calculation, the correction factor Z for the dependency of the test liquid on temperature and air pressure must be taken into consideration, either for every individual value or during mean value calculation (see Chapter 9).

Systematic error of measurement e_s in microliter:

$$e_s = \bar{x} - x_{\text{nominal}}$$

Systematic error of measurement e_s in percent:

$$e_s = 100 \frac{(\bar{x} - x_{\text{nominal}})}{x_{\text{nominal}}}$$

Calculation of the random error of measurement

Random error as repeatability standard deviation s:

$$s = \sqrt{\frac{\sum (x_i \cdot z - \bar{x})^2}{n - 1}}$$

Random error as coefficient of variation CV in percent:

$$CV (\%) = \frac{s}{\bar{x}} \cdot 100$$

The permitted specifications of the pipette which is to be tested can be found in the instruction manual or in "Technical Specification" in chapter 10 of this SOP.

5 Sterilizing and cleaning

Sterilization

The instruction manual of the pipette contains information on cleaning with solvents or autoclaving (121 °C, 20 min.).

The Eppendorf **Reference**[®] pipettes and the **Biomaster**[®] are fully autoclavable.

Before autoclaving, unscrew the upper housing from the lower housing of the pipette by rotating the central junction once. This allows vapor to enter the device more easily. Do not reassemble until the pipette has cooled down to room temperature.

Only the lower parts of the **Eppendorf Research**[®] and **Research**[®] **pro** pipettes are autoclavable.

With the single-channel versions, the tip ejector is taken off the pipette and the lower part of the pipette is unscrewed (see instruction manual).

With the multi-channel pipettes, the complete lower part is autoclavable.

After autoclaving do not reassemble the pipette until it has cooled down to room temperature.

Varispenser[®] **4960/61/62** should not be disassembled for autoclaving.

Varispenser[®] **plus 4961**: Move the discharge valve toggle into the dispensing position (→). Disengage the volume setting button, push it into the middle position and leave it disengaged. Place the dispenser onto a cloth and autoclave the device. Ensure that the device does not come into contact with hot metal surfaces. Do not use the dispenser until it has cooled down to room temperature.

The **Top Buret 4965** cannot be autoclaved.

The **Varipette**[®] **4720**, the **Multipette**[®] **4780**, the **Multipette**[®] **plus 4980**, the **Multipette**[®] **pro**, the **Multipette**[®] **stream** and the **Multipette**[®] **Xstream** are not autoclavable.

Cleaning

If not otherwise stated in the instruction manual, all parts of the pipette can be cleaned with soap solution or isopropanol. The parts must then be rinsed with distilled water. Do not reassemble the parts until they have dried completely.

After cleaning, manual pipettes should be lubricated lightly using special silicone grease.

6 Checking for leaks

To check for leaks, hold the pipette vertically for approximately 15 sec. with a filled tip. Do not touch the pipette tip. Observe the meniscus of the liquid in the pipette tip. Adjust variable pipettes before setting the nominal volume.

If there is a leak, a droplet is visible on the pipette tip.

The leak test can also be conducted with transparent PVC tubing or a leak-test bottle.

For this purpose, a 20 cm-long tube is attached to the tip of the pipette.

Tubing sizes:	10 – 100 μ l	0.5 – 1 mm inner diameter
	100 – 500 μ l	1.5 – 2 mm inner diameter
	500 – 2,500 μ l	5 mm inner diameter

Hold the pipette vertically, aspirate liquid (colored liquid may be used if desired) and mark the meniscus level on the tube. The meniscus must not sink in the tubing which hangs freely, even after liquid has been aspirated and pipetted several times (approx. 15 sec.).

7 Troubleshooting

(siehe auch Bedienungsanleitung)

Error	Cause	Solution
Droplets visible on the inside of the pipette tip.	<ul style="list-style-type: none"> – Uneven wetting of the plastic wall. 	<ul style="list-style-type: none"> – Attach a new pipette tip.
Pipette drips; incorrect pipetting volume.	<ul style="list-style-type: none"> – Tip is loose. – Incorrect pipette tip. <p>Pipette leaks because:</p> <ul style="list-style-type: none"> – the piston is contaminated. – the piston is damaged. – the seals are damaged. – the nose cone is loose. 	<ul style="list-style-type: none"> – Push tip on tightly. – Use Original Eppendorf Tip. – Clean the piston and lubricate lightly. – Replace the piston and piston seals and lubricate lightly. – Replace all seals and lubricate the piston lightly. – Tighten the nose cone slightly using the key provided; replace the nose cone if necessary.
Liquid cannot be aspirated correctly; dripping occurs.	<ul style="list-style-type: none"> – Combitip plus is leaking. – Temperature of Combitip plus has risen. 	<ul style="list-style-type: none"> – Replace the Combitip plus. – Ensure that the temperature is uniform as liquid expands when heated.
Control button jams or does not move smoothly.	<ul style="list-style-type: none"> – Piston is contaminated. – Seal is contaminated. – Piston is damaged. – Solvent vapors have entered device. 	<ul style="list-style-type: none"> – Clean the piston and lubricate lightly. – Disassemble the pipette; clean all seals and replace if necessary; lubricate the piston lightly. – Replace the piston and piston seals and lubricate lightly. – Unscrew the pipette at the central junction and air the pipette. Clean the piston and lubricate lightly.

8 Adjustment

The pipettes have been calibrated by the manufacturer with bidistilled, degassed water in accordance with ISO 3696 under the measuring conditions described in Section 2.

If the precision of the pipetted volume is questionable, consider the following points before readjusting the pipette:

- Has the pipette been checked for leaks (see Sec. 6)? Exception: Biomaster 4830.
- Is the temperature of the liquid the same as:
 - the temperature of the device?
 - the ambient temperature?
- Is there a draft in the room?
- Has the correct volume been set?
- Have the density of the liquid and the air pressure been taken into consideration?
- Does the density of the test liquid deviate from that of bidistilled, degassed water?
- Is the mode of operation correct (see Sections 3 and 4)?
- Have Original Pipette Tips been attached?

Volume errors may occur during the pipetting of liquids which have a high vapor pressure or a density which is significantly different to that of water.

Do not adjust the device until all of these points have been examined.

8.1 Adjusting pipettes (adjustable-volume)

The adjustment of adjustable-volume pipettes (**Eppendorf Research[®]**, **Research[®] Family 3111, 3114, Eppendorf Reference[®] variabel, Biomaster[®] 4830 and Titerman[®] 4908**) is a zero-point shift.

1. In accordance with EN ISO 8655, Part 6, the temperature of the device, the Original Eppendorf Tip, the test liquid and the ambient conditions must be the same (15 – 30 °C constant to ± 0.5 °C) during testing.
2. Set the device to the smallest possible volume, which should not be less than 10 % of the nominal volume.
3. When using single-channel pipettes, attach an appropriate Original Eppendorf Tip to the pipette. With multi-channel pipettes, the tip can be attached to any one channel.
4. Pipette the volume ten times. The actual volume is calculated from the mean value obtained from these weighings (use the Z factor to convert mg into μl).
5. To adjust the device, insert the tool provided into the appropriate opening or other position and set the actual volume (see Fig. 1 – 7 or consult the instruction manual).
6. Check the volume which has been set by carrying out a measurement once again. If the nominal volume does not correspond with the result of the measurement, repeat points 2 – 5.
7. After adjustment, check the accuracy of the measured values of the nominal volume and of 50 % of the nominal volume.

8.2 Adjusting pipettes (fixed-volume)

Fixed-volume pipettes are adjusted in the same way as adjustable-volume pipettes (with fixed-volume pipettes, 10 measured values of the nominal volume are checked).

8 Adjustment

Adjusting the Eppendorf Reference[®] fixed-volume:

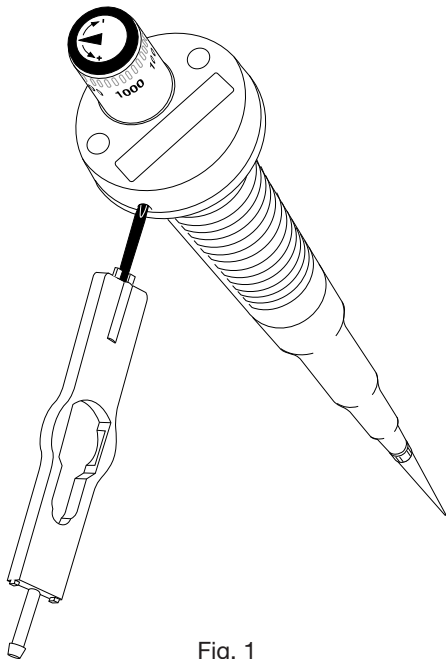

Fig. 1

To facilitate relocation of the initial setting, attach the label provided (calibration aid) to the control button, as described in the instruction manual.

Using side B of the universal tool provided (order no. 4910 092.001), loosen the inner screw until the control button can be rotated (see Fig. 1). Adjust the control button to the volume which has been obtained under point 4 (see instruction manual). One revolution of the control button is equivalent to the following (figures based on water):

Reference fixed-volume	Vol. / rotation
1, 2, 5, 10 μ l	approx. 0.5 μ l
10, 20 μ l	approx. 1 μ l
25, 50 μ l	approx. 2.4 μ l
100 μ l	approx. 5 μ l
200, 250 μ l	approx. 12 μ l
500, 1,000 μ l	approx. 46 μ l
1,500, 2,000, 2,500 μ l	approx. 118 μ l

Adjusting the Unipette[®] 3190:

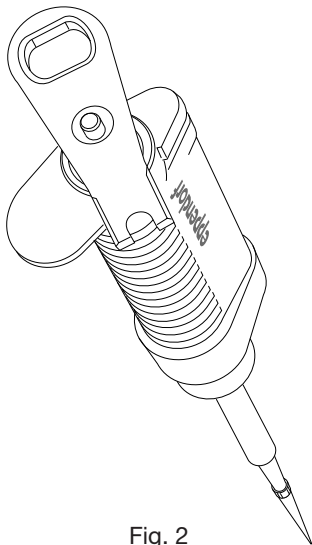

Fig. 2

Unscrew the volume identification ring and pull off the control button.

Position the tool contained in the service kit (order no. 3190 875.007) over the piston shaft and change the stroke by turning the stop screw (see Fig. 2).

Caution:

The maximum setting is two revolutions.

(one revolution is equal to
approx. 10 – 100 μ l with 1 – 5 μ l,
approx. 200 – 1,000 μ l with 10 – 38 μ l.)

To decrease the volume,
turn the control button clockwise.

To increase the volume,
turn the control button counterclockwise
(see instruction manual).

8 Adjustment

Adjusting the Eppendorf Research® fixed-volume:

Insert side D of the key provided (order no. 3110 110.013) horizontally into the upper half of the calibration opening at the side of the pipette grip (see Fig. 4). Move the key into a vertical position.

Move the adjusting ring (in the – or + direction) to set the piston stroke of the pipette. This does not affect the setting of the digital indicator.

One revolution is equal to the following:

Research 3112 (fixed-volume)		
Volume range		
10	approx.	0.8 µl
20	approx.	0.8 µl
25	approx.	0.8 µl
50	approx.	0.8 µl
100	approx.	0.8 µl
200	approx.	38 µl
250	approx.	38 µl
500	approx.	38 µl
1,000	approx.	38 µl

Adjusting the Eppendorf Reference® adjustable volume:

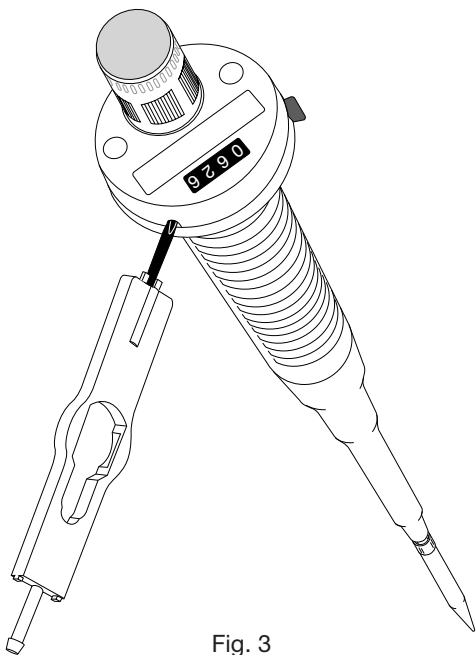

Fig. 3

Turn the universal tool provided (order no. 4919 092.001) to set the digital indicator of the pipette to its actual volume (the measurement in point 4). The piston stroke should remain unchanged. See Fig. 3.

Remove the tool. Set the Reference to its nominal volume in the usual way (see instruction manual).

8 Adjustment

Adjusting the Eppendorf Research® 3110, Research Family 3111:

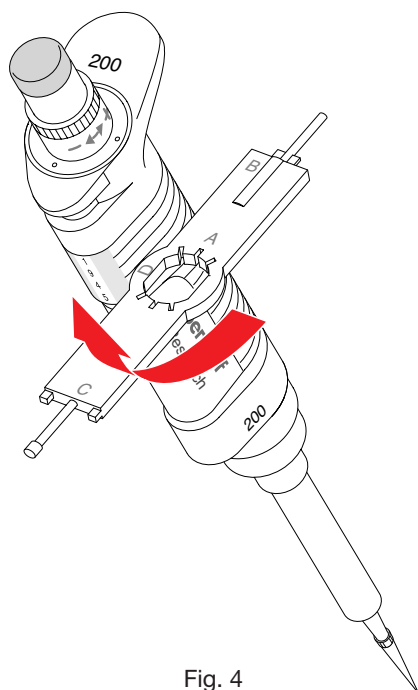

Fig. 4

Insert side D of the key provided (order no. 3110 110.013) horizontally into the upper half of the calibration opening at the side of the pipette grip (see Fig. 4). Move the key into a vertical position.

Move the adjusting ring (in the – or + direction) to set the piston stroke of the pipette. This does not affect the setting of the digital indicator.

One revolution is equal to the following:

Research 3110 / 3111

Volume range			
0.1	–	2.5 µl	approx. 0.1 µl
0.5	–	10 µl	approx. 0.5 µl
2	–	20 µl	approx. 1 µl
10	–	100 µl	approx. 5 µl
20	–	200 µl	approx. 10 µl
100	–	1,000 µl	approx. 50 µl
500	–	5,000 µl	approx. 250 µl
1	–	10 ml	approx. 510 µl

Adjusting the Eppendorf Research® Multi-channel:

Insert side D of the key provided (order no. 3110 110.013) horizontally into the upper half of the calibration opening at the side of the pipette grip (see Fig. 4). Move the key into a vertical position.

Move the adjusting ring (in the – or + direction) to set the piston stroke of the pipette. This does not affect the setting of the digital indicator.

One revolution is equal to the following:

Research 3114 (Multi-channel)

Volume range			
0.5	–	10 µl	approx. 0.5 µl
10	–	100 µl	approx. 5 µl
30	–	300 µl	approx. 10 µl

After removing the key, move the adjusting ring to and fro until the digital indicator system and the stroke system click together (see instruction manual).

8 Adjustment

Adjusting the Biomaster® 4830:

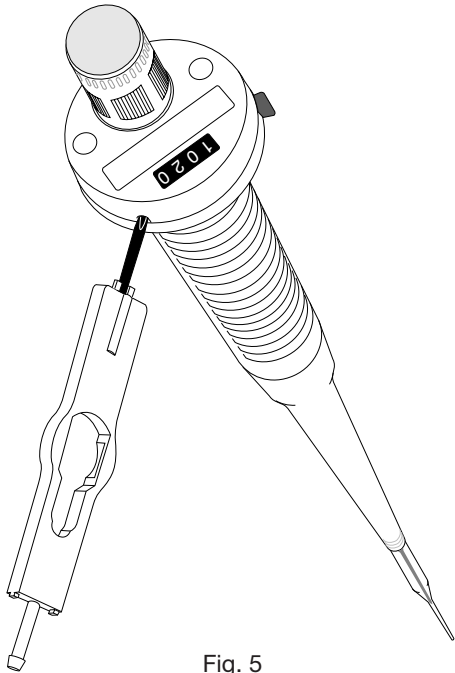

Fig. 5

Turn the universal tool provided (order no. 4910 092.001) to set the digital indicator of the pipette to its actual volume (the measurement in point 4). The piston stroke should remain unchanged. See Fig. 5.

Remove the tool. Set the Biomaster 4830 to its nominal volume in the usual way (see instruction manual).

Adjusting the Titerman® 4908:

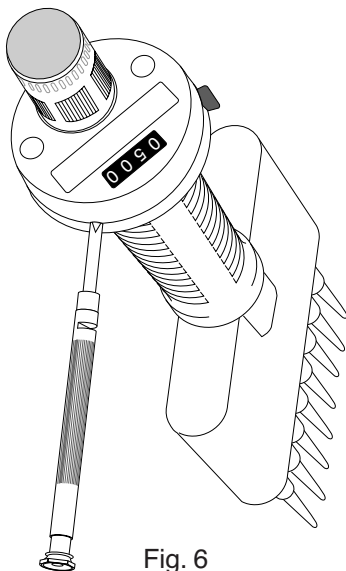

Fig. 6

Using a Phillips screwdriver (size 0, order no. 4908 809.004), set the digital indicator of the pipette to the actual volume. (the measurement in point 4). Make sure that the control button is blocked (push in the control button fully). See Fig. 6.

Remove the Phillips screwdriver. Set the Titerman to its nominal volume in the usual way (see instruction manual).

8 Adjustment

Adjusting the Varispenser® plus 4961:

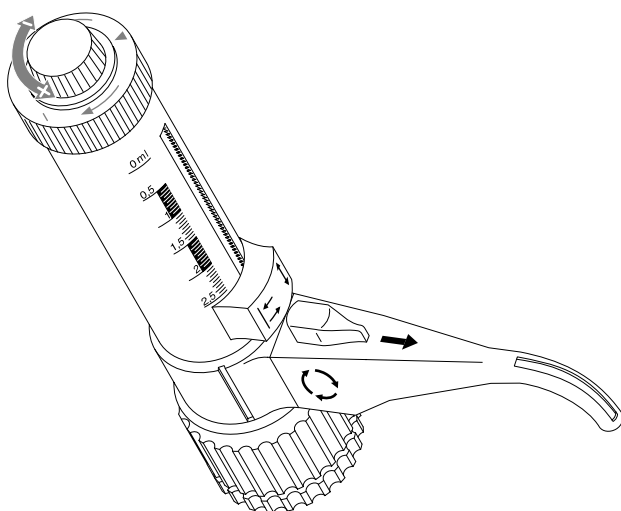

Fig. 7

Adjust the Varispenser 4961 by turning the fine adjustment (see Fig. 7). One rotation is equivalent to the smallest dispensing step.

Rotation of the button in the "+" direction:
increase in volume.

Rotation of the button in the "-" direction:
decrease in volume.

(Factory-set adjustment at 20 °C with degassed, bidistilled water; see instruction manual.)

8.3 Adjusting for liquids with a density different to that of bidistilled, degassed water

It is possible to adjust the pipettes described on the previous pages for one volume of a liquid with a density different to that of water so that the volume displayed corresponds with the pipetted volume.

Caution: With adjustable pipettes, all other values are then adjusted as well!

The adjustment process is similar to the procedure described in Sec. 8.1 and 8.2. The difference is that the mean value of the weighings is converted into microliters using the following formula:

$$\text{Pipetting volume} = \frac{\text{Mean value of weighings}}{\text{Density of liquid weighed}}$$

The resulting value is the actual value to which the volume display of adjustable-volume pipettes or the volume of fixed-volume pipettes is adjusted.

Caution: The value set for this particular liquid must be checked gravimetrically. A pipette set in this way only provides a value corresponding with the digital indicator display/volume ring for the liquid used and for the volume set. If necessary, the setting must be corrected and checked again.

After the pipette has been adjusted to another value, the device must be clearly identifiable (e.g. a label should be applied).



The manufacturer's warranty is invalidated after adjustment has taken place!

9 Factor Z for distilled water

Factor Z ($\mu\text{l} / \text{mg}$) in accordance with EN ISO 8655 as a function of the temperature and air pressure for distilled water

Temperature (°C)	KPa						
	80	85	90	95	100	101.3	105
15	1.0017	1.0018	1.0019	1.0019	1.0020	1.0020	1.0020
15.5	1.0018	1.0019	1.0019	1.0020	1.0020	1.0020	1.0021
16	1.0019	1.0020	1.0020	1.0021	1.0021	1.0021	1.0022
16.5	1.0020	1.0020	1.0021	1.0021	1.0022	1.0022	1.0022
17	1.0021	1.0021	1.0022	1.0022	1.0023	1.0023	1.0023
17.5	1.0022	1.0022	1.0023	1.0023	1.0024	1.0024	1.0024
18	1.0022	1.0023	1.0023	1.0024	1.0025	1.0025	1.0025
18.5	1.0023	1.0024	1.0024	1.0025	1.0025	1.0026	1.0026
19	1.0024	1.0025	1.0025	1.0026	1.0026	1.0027	1.0027
19.5	1.0025	1.0026	1.0026	1.0027	1.0027	1.0028	1.0028
20	1.0026	1.0027	1.0027	1.0028	1.0028	1.0029	1.0029
20.5	1.0027	1.0028	1.0028	1.0029	1.0029	1.0030	1.0030
21	1.0028	1.0029	1.0029	1.0030	1.0031	1.0031	1.0031
21.5	1.0030	1.0030	1.0031	1.0031	1.0032	1.0032	1.0032
22	1.0031	1.0031	1.0032	1.0032	1.0033	1.0033	1.0033
22.5	1.0032	1.0032	1.0033	1.0033	1.0034	1.0034	1.0034
23	1.0033	1.0033	1.0034	1.0034	1.0035	1.0035	1.0036
23.5	1.0034	1.0035	1.0035	1.0036	1.0036	1.0036	1.0037
24	1.0035	1.0036	1.0036	1.0037	1.0037	1.0038	1.0038
24.5	1.0037	1.0037	1.0038	1.0038	1.0039	1.0039	1.0039
25	1.0038	1.0038	1.0039	1.0039	1.0040	1.0040	1.0040
25.5	1.0039	1.0040	1.0040	1.0041	1.0041	1.0041	1.0042
26	1.0040	1.0041	1.0041	1.0042	1.0042	1.0043	1.0043
26.5	1.0042	1.0042	1.0043	1.0043	1.0044	1.0044	1.0044
27	1.0043	1.0044	1.0044	1.0045	1.0045	1.0045	1.0046
27.5	1.0045	1.0045	1.0046	1.0046	1.0047	1.0047	1.0047
28	1.0046	1.0046	1.0047	1.0047	1.0048	1.0048	1.0048
28.5	1.0047	1.0048	1.0048	1.0049	1.0049	1.0050	1.0050
29	1.0049	1.0049	1.0050	1.0050	1.0051	1.0051	1.0051
29.5	1.0050	1.0051	1.0051	1.0052	1.0052	1.0052	1.0053
30	1.0052	1.0052	1.0053	1.0053	1.0054	1.0054	1.0054

10 Technical specifications

10.1 Fixed-volume pipettes

Eppendorf Reference [®] fixed-volume		
Volume	Systematic error	Random error
1 µl	± 2.5 %	≤ 1.8 %
2 µl	± 2.0 %	≤ 1.2 %
5 µl	± 1.5 %	≤ 0.8 %
10 µl	± 1.0 %	≤ 0.5 %
20 µl / 25 µl	± 0.8 %	≤ 0.3 %
50 µl	± 0.7 %	≤ 0.3 %
100 – 2,500 µl	± 0.6 %	≤ 0.2 %

Eppendorf Research [®] fixed-volume		
Volume	Systematic error	Random error
10 µl	± 1.8 %	≤ 0.6 %
20 µl	± 1.0 %	≤ 0.3 %
25 µl	± 1.0 %	≤ 0.3 %
50 µl	± 0.7 %	≤ 0.3 %
100 µl	± 0.6 %	≤ 0.2 %
200 µl	± 0.6 %	≤ 0.2 %
250 µl	± 0.6 %	≤ 0.2 %
500 µl	± 0.6 %	≤ 0.2 %
1,000 µl	± 0.6 %	≤ 0.2 %

10.2 Adjustable pipettes

Eppendorf Reference [®] adjustable-volume		
Volume	Systematic error	Random error
0.1 – 2.5 µl		
0.2 µl	± 12.0 %	≤ 6.0 %
1 µl	± 2.5 %	≤ 1.5 %
2.5 µl	± 1.4 %	≤ 0.7 %
0.5 – 10 µl		
0.5 µl	± 5.0 %	≤ 2.8 %
1 µl	± 2.5 %	≤ 1.8 %
5 µl	± 1.5 %	≤ 0.8 %
10 µl	± 1.0 %	≤ 0.4 %
2 – 20 µl (gray)		
2 µl	± 3.0 %	≤ 2.0 %
10 µl	± 1.0 %	≤ 0.5 %
20 µl	± 0.8 %	≤ 0.3 %
2 – 20 µl (yellow)		
2 µl	± 5.0 %	≤ 1.5 %
10 µl	± 1.2 %	≤ 0.6 %
20 µl	± 1.0 %	≤ 0.3 %
10 – 100 µl		
10 µl	± 3.0 %	≤ 0.7 %
50 µl	± 1.0 %	≤ 0.3 %
100 µl	± 0.8 %	≤ 0.15 %
50 – 200 µl		
50 µl	± 1.0 %	≤ 0.3 %
100 µl	± 0.9 %	≤ 0.3 %
200 µl	± 0.6 %	≤ 0.2 %
50 – 250 µl		
50 µl	± 1.4 %	≤ 0.3 %
100 µl	± 1.1 %	≤ 0.3 %
250 µl	± 0.6 %	≤ 0.2 %
100 – 1,000 µl		
100 µl	± 3.0 %	≤ 0.3 %
500 µl	± 1.0 %	≤ 0.2 %
1,000 µl	± 0.6 %	≤ 0.2 %
500 – 2,500 µl		
500 µl	± 1.5 %	≤ 0.3 %
1,250 µl	± 0.8 %	≤ 0.2 %
2,500 µl	± 0.6 %	≤ 0.2 %

Testliquid: Water, distilled or deionised
 Reference temperature: 15 – 30 °C, constant ± 0.5 °C
 Numer of determinations: 10, in accordance with EN ISO 8655
 with Original Eppendorf Pipette tips

Technical specifications subject to change!

10 Technical specifications

10.2 Adjustable pipettes

Eppendorf Research® adjustable		
Volume	Systematic error	Random error
0.1 – 2.5 µl		
0.2 µl	± 12.0 %	≤ 6.0 %
1 µl	± 2.5 %	≤ 1.5 %
2.5 µl	± 1.4 %	≤ 0.7 %
0.5 – 10 µl		
1 µl	± 2.5 %	≤ 1.8 %
5 µl	± 1.5 %	≤ 0.8 %
10 µl	± 1.0 %	≤ 0.4 %
2 – 20 µl		
2 µl	± 5.0 %	≤ 1.5 %
10 µl	± 1.2 %	≤ 0.6 %
20 µl	± 1.0 %	≤ 0.3 %
10 – 100 µl		
10 µl	± 3.0 %	≤ 1.0 %
50 µl	± 1.0 %	≤ 0.3 %
100 µl	± 0.8 %	≤ 0.2 %
20 – 200 µl		
20 µl	± 2.5 %	≤ 0.7 %
100 µl	± 1.0 %	≤ 0.3 %
200 µl	± 0.6 %	≤ 0.2 %
100 – 1,000 µl		
100 µl	± 3.0 %	≤ 0.6 %
500 µl	± 1.0 %	≤ 0.2 %
1,000 µl	± 0.6 %	≤ 0.2 %
500 – 5,000 µl		
500 µl	± 2.4 %	≤ 0.6 %
2,500 µl	± 1.2 %	≤ 0.25 %
5,000 µl	± 0.6 %	≤ 0.15 %
1 – 10 ml		
1,000 µl	± 3.0 %	≤ 0.6 %
5,000 µl	± 0.8 %	≤ 0.2 %
10,000 µl	± 0.6 %	≤ 0.15 %

10.2 Adjustable pipettes

Eppendorf Research® pro (single channel)			
Volume range	Volume	Systematic error	Random error
0.5 – 10 µl	1 µl	± 2.5 %	≤ 1.8 %
	5 µl	± 1.5 %	≤ 0.8 %
	10 µl	± 1.0 %	≤ 0.4 %
5 – 100 µl	10 µl	± 2.0 %	≤ 1.0 %
	50 µl	± 1.0 %	≤ 0.3 %
	100 µl	± 0.8 %	≤ 0.2 %
20 – 300 µl	30 µl	± 2.5 %	≤ 0.7 %
	100 µl	± 1.0 %	≤ 0.3 %
	300 µl	± 0.8 %	≤ 0.2 %
50 – 1,000 µl	100 µl	± 3.0 %	≤ 0.6 %
	500 µl	± 1.0 %	≤ 0.2 %
	1,000 µl	± 0.6 %	≤ 0.2 %
100 – 5,000 µl	500 µl	± 3.0 %	≤ 0.6 %
	2,500 µl	± 1.2 %	≤ 0.25 %
	5,000 µl	± 0.6 %	≤ 0.15 %

Biomaster®		
Volume	Systematic error	Random error
2 µl	± 6.0 %	≤ 4.0 %
3 µl	± 5.0 %	≤ 3.0 %
5 µl	± 4.0 %	≤ 2.0 %
10 µl	± 3.0 %	≤ 1.5 %
20 µl	± 2.5 %	≤ 0.8 %

Varipette® 4720		
Volume	Systematic error	Random error
Varipette 4720 and Varitip S		
2.5 ml	± 1.0 %	≤ 0.2 %
5 ml	± 0.4 %	≤ 0.2 %
10 ml	± 0.3 %	≤ 0.2 %
Varipette 4720 and Varitip P		
1 ml	± 0.6 %	≤ 0.2 %
5 ml	± 0.5 %	≤ 0.1 %
10 ml	± 0.3 %	≤ 0.1 %

Testliquid:	Water, distilled or deionised
Reference temperature:	15 – 30 °C, constant ± 0.5 °C
Numer of determinations:	10, in accordance with EN ISO 8655 with Original Eppendorf Pipette tips

Technical specifications subject to change!

10 Technical specifications

10.3 Multi-channel pipettes

Eppendorf Research® multi-channel			
Volume range	Volume	Systematic error	Random error
0.5 – 10 µl	1 µl	± 8.0 %	≤ 5.0 %
	5 µl	± 4.0 %	≤ 2.0 %
	10 µl	± 2.0 %	≤ 1.0 %
10 – 100 µl	10 µl	± 3.0 %	≤ 2.0 %
	50 µl	± 1.0 %	≤ 0.8 %
	100 µl	± 0.8 %	≤ 0.3 %
30 – 300 µl	30 µl	± 3.0 %	≤ 1.0 %
	150 µl	± 1.0 %	≤ 0.5 %
	300 µl	± 0.6 %	≤ 0.3 %

Eppendorf Research® pro (multi channel)			
Volume range	Volume	Systematic error	Random error
0.5 – 10 µl	1 µl	± 5.0 %	≤ 3.0 %
	5 µl	± 3.0 %	≤ 1.5 %
	10 µl	± 2.0 %	≤ 0.8 %
5 – 100 µl	10 µl	± 2.0 %	≤ 2.0 %
	50 µl	± 1.0 %	≤ 0.8 %
	100 µl	± 0.8 %	≤ 0.25 %
20 – 300 µl	30 µl	± 2.5 %	≤ 1.0 %
	150 µl	± 1.0 %	≤ 0.5 %
	300 µl	± 0.6 %	≤ 0.25 %
50 – 1,200 µl	120 µl	± 6.0 %	≤ 0.9 %
	600 µl	± 3.0 %	≤ 0.4 %
	1,200 µl	± 1.2 %	≤ 0.3 %

Testliquid:	Water, distilled or deionised
Reference temperature:	15 – 30 °C, constant ± 0.5 °C
Numer of determinations:	10, in accordance with EN ISO 8655 with Original Eppendorf Pipette tips

Technical specifications subject to change!

10 Technical specifications

10.4 Multipettes

Multipette® plus			
Combitip plus	Volume	Systematic error	Random error
0.1 ml	2 µl	± 1.6 %	≤ 3.0 %
	20 µl	± 1.0 %	≤ 2.0 %
0.2 ml	4 µl	± 1.3 %	≤ 2.0 %
	40 µl	± 0.8 %	≤ 1.5 %
0.5 ml	10 µl	± 0.9 %	≤ 1.5 %
	100 µl	± 0.8 %	≤ 0.6 %
1.0 ml	20 µl	± 0.9 %	≤ 0.9 %
	200 µl	± 0.6 %	≤ 0.4 %
2.5 ml	50 µl	± 0.8 %	≤ 0.8 %
	500 µl	± 0.5 %	≤ 0.3 %
5.0 ml	100 µl	± 0.6 %	≤ 0.6 %
	1,000 µl	± 0.5 %	≤ 0.25 %
10.0 ml	200 µl	± 0.5 %	≤ 0.6 %
	2,000 µl	± 0.5 %	≤ 0.25 %
25.0 ml	500 µl	± 0.4 %	≤ 0.6 %
	5,000 µl	± 0.3 %	≤ 0.25 %
50.0 ml	1,000 µl	± 0.3 %	≤ 0.5 %
	10,000 µl	± 0.3 %	≤ 0.25 %

Multipette® pro			
Combitip plus	Volume	Systematic error	Random error
0.1 ml	10 µl	± 1.6 %	≤ 2.5 %
	100 µl	± 1.0 %	≤ 0.5 %
0.2 ml	20 µl	± 1.3 %	≤ 1.5 %
	200 µl	± 1.0 %	≤ 0.5 %
0.5 ml	50 µl	± 0.9 %	≤ 0.8 %
	500 µl	± 0.9 %	≤ 0.3 %
1.0 ml	100 µl	± 0.9 %	≤ 0.55 %
	1,000 µl	± 0.6 %	≤ 0.2 %
2.5 ml	250 µl	± 0.8 %	≤ 0.45 %
	2,500 µl	± 0.5 %	≤ 0.15 %
5.0 ml	500 µl	± 0.8 %	≤ 0.35 %
	5,000 µl	± 0.5 %	≤ 0.15 %
10.0 ml	1,000 µl	± 0.5 %	≤ 0.25 %
	10,000 µl	± 0.4 %	≤ 0.15 %
50.0 ml	5,000 µl	± 0.3 %	≤ 0.25 %
	50,000 µl	± 0.3 %	≤ 0.15 %

Testliquid: Water, distilled or deionised
 Reference temperature: 15 – 30 °C, constant ± 0.5 °C
 Numer of determinations: 10, in accordance with EN ISO 8655
 with Original Eppendorf Pipette tips

Technical specifications subject to change!

Multipette® stream / Multipette® Xstream						
Combitip plus	Dispensing range (min./max.)	Increment	Test volumes	Systematic error (Bias; Inaccuracy) [%]	Random error (Imprecision; CV) [%]	
0.1 mL	1–100 µl	0.1 µl	10 µl	±1.6	≤ 2.5	
			50 µl	±1.0	≤ 1.5	
			100 µl	±1.0	≤ 0.5	
0.2 mL	2–200 µl	0.2 µl	20 µl	±1.3	≤ 1.5	
			100 µl	±1.0	≤ 1.0	
			200 µl	±1.0	≤ 0.5	
0.5 mL	5–500 µl	0.5 µl	50 µl	±0.9	≤ 0.8	
			250 µl	±0.9	≤ 0.5	
			500 µl	±0.9	≤ 0.3	
1.0 mL	10–1,000 µl	1.0 µl	100 µl	±0.9	≤ 0.55	
			500 µl	±0.6	≤ 0.3	
			1,000 µl	±0.6	≤ 0.2	
2.5 mL	25–2,500 µl	2.5 µl	250 µl	±0.8	≤ 0.45	
			1,250 µl	±0.5	≤ 0.3	
			2,500 µl	±0.5	≤ 0.15	

10 Technical specifications

Multipette® stream / Multipette® Xstream					
Combitip plus	Dispensing range (min./max.)	Increment	Test volumes	Systematic error (Bias; Inaccuracy) [%]	Random error (Imprecision; CV) [%]
5 mL	50–5,000 µl	5 µl	500 µl	±0.8	≤ 0.35
			2500 µl	±0.5	≤ 0.25
			5000 µl	±0.5	≤ 0.15
10 mL	0.10–10.00 ml	0.01 ml	1.00 ml	±0.5	≤ 0.25
			5.00 ml	±0.4	≤ 0.25
			10.00 ml	±0.4	≤ 0.15
25 mL	0.25–25.00 ml	0.025 ml	2.50 ml	±0.3	≤ 0.25
			12.50 ml	±0.3	≤ 0.25
			25.00 ml	±0.3	≤ 0.15
50 mL	0.50–50.00 ml	0.05 ml	5.00 ml	±0.3	≤ 0.25
			25.00 ml	±0.3	≤ 0.2
			50.00 ml	±0.3	≤ 0.15

The above-mentioned technical data apply only when the Combitip plus is being used.

Test conditions and test evaluation in compliance with ISO 8655, Part 6;

test using a standardized fine balance with a moisture trap.

Volume tests in Dis mode; set speed levels: 7;

number of determinations: 10; use of water in accordance with ISO 3696;

test at 20 °C – 25 °C ±0.5 °C; dispensing against the tube wall.

Technical specifications subject to change!

10.5 Bottle-top dispensers / burettes

Varispenser® plus and Varispenser®						
Size	Volume range	Volume tested	Dispensing step	Systematic error	Random error	
1	0.1 – 2.50 ml	2.5 ml	0.05 ml	± 0.6%	≤ 0.1 %	
2	1.00 – 5.00 ml	5.0 ml	0.10 ml	± 0.5 %	≤ 0.1 %	
3	2.00 – 10.0 ml	10.0 ml	0.20 ml	± 0.5 %	≤ 0.1 %	
4	5.00 – 25.0 ml	25.0 ml	0.50 ml	± 0.5 %	≤ 0.1 %	
5	10.0 – 50.0 ml	50.0 ml	1.00 ml	± 0.5 %	≤ 0.1 %	
6	20.0 – 100.0 ml	100.0 ml	2.00 ml	± 0.5 %	≤ 0.1 %	

Top Buret			
Model	Volume	Systematic error	Random Error
M	25 ml	± 0.2 %	≤ 0.1 %
H	50 ml	± 0.2 %	≤ 0.1 %

Testliquid: Water, distilled or deionised

Reference temperature: 15 – 30 °C, constant ± 0.5 °C

Numer of determinations: 10, in accordance with EN ISO 8655

Technical specifications subject to change!

10 Technical specifications

10.6 Error limits in accordance with EN ISO 8655

In accordance with EN ISO 8655, the error limits are always based on the overall system of pipette and tip together. For the maximum permissible errors of pipettes with intermediate nominal volume between those given in the table, the absolute values for the next greater nominal volume shall apply.

The error limits in accordance with the latest version of the EN ISO 8655 standard and based on volume are contained in the following tables:

Piston pipettes, fixed volume and adjustable, single channel				
Nominal volume	Maximum permissible systematic errors		Maximum permissible random errors	
	1 µl	± 5.0 %	± 0.05 µl	± 5.0 %
2 µl	± 4.0 %	± 0.08 µl	± 2.0 %	± 0.04 µl
5 µl	± 2.5 %	± 0.125 µl	± 1.5 %	± 0.075 µl
10 µl	± 1.2 %	± 0.12 µl	± 0.8 %	± 0.08 µl
20 µl	± 1.0 %	± 0.2 µl	± 0.5 %	± 0.1 µl
50 µl	± 1.0 %	± 0.5 µl	± 0.4 %	± 0.2 µl
100 µl	± 0.8 %	± 0.8 µl	± 0.3 %	± 0.3 µl
200 µl	± 0.8 %	± 1.6 µl	± 0.3 %	± 0.6 µl
500 µl	± 0.8 %	± 4.0 µl	± 0.3 %	± 1.5 µl
1,000 µl	± 0.8 %	± 8.0 µl	± 0.3 %	± 3.0 µl
2,000 µl	± 0.8 %	± 16.0 µl	± 0.3 %	± 6.0 µl
5,000 µl	± 0.8 %	± 40.0 µl	± 0.3 %	± 15.0 µl
10,000 µl	± 0.6 %	± 60.0 µl	± 0.3 %	± 30.0 µl

Multi-channel pipettes:

The maximum permissible systematic and random errors of multi-channel piston pipettes shall be equal to twice the values specified for single-channel piston pipettes.

10 Technical specifications

10.6 Error limits in accordance with EN ISO 8655

Positive displacement pipettes (Biomaster)				
Nominal volume	Maximum permissible systematic errors		Maximum permissible random errors	
	5 μ l	$\pm 2.5 \%$	$\pm 0.13 \mu$ l	$\pm 1.5 \%$
10 μ l	$\pm 2.0 \%$	$\pm 0.2 \mu$ l	$\pm 1.0 \%$	$\pm 0.1 \mu$ l
20 μ l	$\pm 2.0 \%$	$\pm 0.4 \mu$ l	$\pm 0.8 \%$	$\pm 0.16 \mu$ l
50 μ l	$\pm 1.4 \%$	$\pm 0.7 \mu$ l	$\pm 0.6 \%$	$\pm 0.3 \mu$ l
100 μ l	$\pm 1.5 \%$	$\pm 1.5 \mu$ l	$\pm 0.6 \%$	$\pm 0.6 \mu$ l
200 μ l	$\pm 1.5 \%$	$\pm 3.0 \mu$ l	$\pm 0.4 \%$	$\pm 0.8 \mu$ l
500 μ l	$\pm 1.2 \%$	$\pm 6.0 \mu$ l	$\pm 0.4 \%$	$\pm 2.0 \mu$ l
1,000 μ l	$\pm 1.2 \%$	$\pm 12.0 \mu$ l	$\pm 0.4 \%$	$\pm 4.0 \mu$ l

Dispensers (Multipettes)				
Nominal volume	Maximum permissible systematic errors		Maximum permissible random errors	
	0.001 ml	$\pm 5.0 \%$	$\pm 0.05 \mu$ l	$\pm 5.0 \%$
0.002 ml	$\pm 5.0 \%$	$\pm 0.1 \mu$ l	$\pm 5.0 \%$	$\pm 0.1 \mu$ l
0.003 ml	$\pm 2.5 \%$	$\pm 0.075 \mu$ l	$\pm 3.5 \%$	$\pm 0.11 \mu$ l
0.01 ml	$\pm 2.0 \%$	$\pm 0.2 \mu$ l	$\pm 2.5 \%$	$\pm 0.25 \mu$ l
0.02 ml	$\pm 1.5 \%$	$\pm 0.3 \mu$ l	$\pm 2.0 \%$	$\pm 0.4 \mu$ l
0.05 ml	$\pm 1.0 \%$	$\pm 0.5 \mu$ l	$\pm 1.5 \%$	$\pm 0.75 \mu$ l
0.1 ml	$\pm 1.0 \%$	$\pm 1.0 \mu$ l	$\pm 1.0 \%$	$\pm 1.0 \mu$ l
0.2 ml	$\pm 1.0 \%$	$\pm 2.0 \mu$ l	$\pm 1.0 \%$	$\pm 2.0 \mu$ l
0.5 ml	$\pm 1.0 \%$	$\pm 5.0 \mu$ l	$\pm 0.6 \%$	$\pm 3.0 \mu$ l
1 ml	$\pm 1.0 \%$	$\pm 10.0 \mu$ l	$\pm 0.4 \%$	$\pm 4.0 \mu$ l
2 ml	$\pm 0.8 \%$	$\pm 16.0 \mu$ l	$\pm 0.4 \%$	$\pm 8.0 \mu$ l
5 ml	$\pm 0.6 \%$	$\pm 30.0 \mu$ l	$\pm 0.3 \%$	$\pm 15.0 \mu$ l
10 ml	$\pm 0.5 \%$	$\pm 50.0 \mu$ l	$\pm 0.3 \%$	$\pm 30.0 \mu$ l
25 ml	$\pm 0.5 \%$	$\pm 125.0 \mu$ l	$\pm 0.3 \%$	$\pm 75.0 \mu$ l
50 ml	$\pm 0.5 \%$	$\pm 250 \mu$ l	$\pm 0.25 \%$	$\pm 125.0 \mu$ l
100 ml	$\pm 0.5 \%$	$\pm 500 \mu$ l	$\pm 0.25 \%$	$\pm 250.0 \mu$ l
200 ml	$\pm 0.5 \%$	$\pm 1,000 \mu$ l	$\pm 0.25 \%$	$\pm 500.0 \mu$ l

10 Technical specifications

10.6 Error limits in accordance with EN ISO 8655

Single stroke dispensers (Varispenser)				
Nominal volume	Maximum permissible systematic errors		Maximum permissible random errors	
	0.01 ml	± 2.0 %	± 0.2 µl	± 1.0 %
0.02 ml	± 2.0 %	± 0.4 µl	± 0.5 %	± 0.1 µl
0.05 ml	± 1.5 %	± 0.75 µl	± 0.4 %	± 0.2 µl
0.1 ml	± 1.5 %	± 1.5 µl	± 0.3 %	± 0.3 µl
0.2 ml	± 1.0 %	± 2.0 µl	± 0.3 %	± 0.6 µl
0.5 ml	± 1.0 %	± 5.0 µl	± 0.2 %	± 1.0 µl
1 ml	± 0.6 %	± 6.0 µl	± 0.2 %	± 2.0 µl
2 ml	± 0.6 %	± 12.0 µl	± 0.2 %	± 4.0 µl
5 ml	± 0.6 %	± 30.0 µl	± 0.2 %	± 10.0 µl
10 ml	± 0.6 %	± 60.0 µl	± 0.2 %	± 20.0 µl
25 ml	± 0.6 %	± 150.0 µl	± 0.2 %	± 50.0 µl
50 ml	± 0.6 %	± 300.0 µl	± 0.2 %	± 100.0 µl
100 ml	± 0.6 %	± 600.0 µl	± 0.2 %	± 200.0 µl
200 ml	± 0.6 %	± 1,200 µl	± 0.2 %	± 400.0 µl

Piston burettes				
Nominal volume	Maximum permissible systematic errors		Maximum permissible random errors	
	<1 ml	± 0.6 %	± 6.0 µl	± 0.1 %
2 ml	± 0.5 %	± 10.0 µl	± 0.1 %	± 2.0 µl
5 ml	± 0.3 %	± 15.0 µl	± 0.1 %	± 5.0 µl
10 ml	± 0.3 %	± 30.0 µl	± 0.1 %	± 10.0 µl
20 ml	± 0.2 %	± 40.0 µl	± 0.1 %	± 20.0 µl
25 ml	± 0.2 %	± 50.0 µl	± 0.1 %	± 25.0 µl
50 ml	± 0.2 %	± 100.0 µl	± 0.1 %	± 50.0 µl
100 ml	± 0.2 %	± 200 µl	± 0.1 %	± 100.0 µl

11 Index

- A**
Accessories 28
Adjustment 35 ff
Autoclaving 32
- B**
Balance accuracy 28
Biomaster 4830 32, 35, 39
Bottle-top dispensers 30
Burettes 30
- C**
Calibration 30
Checking for leaks 33
Cleaning 32
Combitip plus 30, 34
- E**
Evaluation 31
Electrostatic charge 28
Error limits 47 ff
Evaporation protection 28
EN ISO 8655 28, 47 ff
- F**
Factor Z 41
Fine balance 28
- H**
Humidity 29
- M**
Measuring station 28
Mode of operation 30
Multi-channel pipettes 30, 32, 38
Multipette 4780 30, 32
Multipette plus 4980 30, 32
- P**
PICASO (Pipette Calibration Software) 28
Photometric test 28
Pipetting conditions 29
- R**
Reference, adjustable 32, 35, 37
Reference, fixed-volume 32, 36
Research, adjustable 32, 35, 38
Research, fixed-volume 32, 37
Room temperature 29
- S**
Sterilization 32
- T**
Technical specifications 42 ff
Temperature differences 29
Test liquid 29
Tips 30, 33, 34, 35
Tool 35
Troubleshooting 34
Titerman 35, 39
- U**
Unipette 3190 36
- V**
Varipette 4720 32
Varispenser 4960/61/62 32, 40
Vessel adapter 28
- W**
Weighing vessel 28

Eppendorf Offices

ASEAN

Eppendorf AG
Regional Office in Malaysia
Tel. +60 3 8023 2769
Fax +60 3 8023 3720
E-Mail: eppendorf@eppendorf.com.my
Internet: www.eppendorf.com.my

AUSTRALIA / NEW ZEALAND

Eppendorf South Pacific Pty. Ltd.
Tel. +61 2 9889 5000
Fax +61 2 9889 5111
E-mail: info@eppendorf.com.au
Internet: www.eppendorf.com.au

AUSTRIA

Eppendorf AG
c/o Schott Austria
Tel. +43 1 29017560
Fax +43 1 290175620
E-Mail: gilch.p@eppendorf.de
Internet: www.eppendorf.com

BRAZIL

Eppendorf do Brasil Ltda.
Tel. +55 11 30 95 93 44
Fax +55 11 30 95 93 40
E-Mail: eppendorf@eppendorf.com.br
Internet: www.eppendorf.com.br

CANADA

Eppendorf Canada, Ltd.
Tel. +1 905 826 5525
Fax +1 905 826 5424
E-Mail: canada@eppendorf.com
Internet: www.eppendorf.com

CHINA

Eppendorf AG
Tel. +86 21 68760880
Fax +86 21 50815371
E-Mail: market.info@eppendorf.cn
Internet: www.eppendorf.cn

FRANCE

EPPENDORF FRANCE S.A.R.L.
Tel. +33 1 30 15 67 40
Fax +33 1 30 15 67 45
E-Mail: eppendorf@eppendorf.fr
Internet: www.eppendorf.fr

GERMANY

Eppendorf Vertrieb
Deutschland GmbH
Tel. +49 2232 418-0
Fax +49 2232 418-155
E-Mail: vertrieb@eppendorf.de
Internet: www.eppendorf.de

INDIA

Eppendorf India Limited
Tel. +91 44 52111314
Fax +91 44 52187405
E-Mail: info@eppendorf.co.in
Internet: www.eppendorf.co.in

ITALY

Eppendorf s.r.l.
Tel. +390 2 55 404 1
Fax +390 2 58 013 438
E-Mail: eppendorf@eppendorf.it
Internet: www.eppendorf.it

JAPAN

Eppendorf Japan Co. Ltd.
Tel. +81 3 5825 2363
Fax +81 3 5825 2365
E-Mail: info@eppendorf.jp
Internet: www.eppendorf.jp

NORDIC

Eppendorf Nordic Aps
Tel. +45 70 22 2970
Fax +45 45 76 7370
E-Mail: nordic@eppendorf.dk
Internet: www.eppendorf.dk

SPAIN

Eppendorf Ibérica S.L.
Tel. +34 91 651 76 94
Fax +34 91 651 81 44
E-Mail: iberica@eppendorf.de
Internet: www.eppendorf.es

SWITZERLAND

Vaudaux-Eppendorf AG
Tel. +41 61 482 1414
Fax +41 61 482 1419
E-Mail: vaudaux@vaudaux.ch
Internet: www.eppendorf.com

UNITED KINGDOM

Eppendorf UK Limited
Tel. +44 1223 200 440
Fax +44 1223 200 441
E-Mail: sales@eppendorf.co.uk
Internet: www.eppendorf.co.uk

USA

Eppendorf North America
Tel. +1 516 334 7500
Fax +1 516 334 7506
E-Mail: info@eppendorf.com
Internet: www.eppendorfna.com

OTHER COUNTRIES

see:
www.eppendorf.com/worldwide

eppendorf

In touch with life

Your local distributor: www.eppendorf.com/worldwide

Eppendorf AG · 22331 Hamburg · Germany · Tel. +49 40 538 01-0 · Fax +49 40 538 01-556 · E-Mail: eppendorf@eppendorf.com

Eppendorf North America, Inc. · One Cantiague Road, P.O. Box 1019 · Westbury, N.Y. 11590-0207 USA
Tel. +1 516 334 7500 · Toll free phone 800 645 3050 · Fax +1 516 334 7506 · E-Mail: info@eppendorf.com

Application Support

Europe, International: Tel. +49 1803 666 789 · E-Mail: support@eppendorf.com
North America: Tel. 800 645 3050 ext. 2258 · E-Mail: support_NA@eppendorf.com
Asia, Pacific: Tel. +603 8023 2769 · E-Mail: support_Asia@eppendorf.com